



Store these instructions with the enclosed maintenance checklist in a safe place. You may also access them on our website.

# Instruction Sheet

## Suspension & Height Adjustment Kit 410001



Take time to familiarize yourself with the use and maintenance of this equipment before using. Please file this Instruction Sheet in an accessible location: the Instruction Sheet must be read and familiar to anyone who is using Southpaw Enterprises Equipment.

**IMPORTANT: Please check equipment immediately for any damage that may have resulted during shipping. If any damage has occurred, please contact Southpaw Enterprises, Inc. immediately.**

### MATERIALS LIST

- 1 - Height Adjuster
- 1 - Rotational Device
- 1 - Therapy Rope w/ Eye Splice (Custom made by Southpaw - 10 feet of rope with metal lined loop permanently attached to one end)
- 3 - Safety snaps
- 1 - Instruction Sheet
- 1 - Maintenance Checklist.

**MINIMUM HEIGHT REQUIREMENT: 8 ft**

**WORKING LOAD: 1000 lbs.**

### Warnings and Precautions

- Failure to properly install a forged steel eyebolt (1/2" or 5/8") may result in serious injury or death. If you have any questions about the installation of the forged steel eyebolt, please contact Southpaw Enterprises Customer Service at 1-800-228-1698.
- With all Southpaw Suspended Equipment a Southpaw Safety Rotational Device (2000) must be used to prevent damage to your equipment. **All warranties are void if the Safety Rotational is not used or if equipment is used with a rotational device not approved by Southpaw.**
- **Regular Maintenance is imperative.** Even the most well built equipment will wear. Nothing is more critical to the safety of a suspended therapeutic activity than inspecting the equipment and suspensions systems regularly. This instruction sheet contains maintenance instructions and inspection points for each component of the system. Following these instructions will help you maintain a safe environment, and will help to catch wear before it becomes dangerous. Failure to follow the maintenance routine can cause severe injury or death.
- Check you ceiling eyebolt for wear and movement. An eyebolt that moves more than 1/4" in any direction is UNSAFE.
- Make sure there is adequate room in all directions for your suspended activity. Southpaw recommends a 6 foot clearance in all directions.
- Use proper personal protection when performing any suspended activity. Clients should wear a safety helmet during any suspended activity.
- Floor mats of proper thickness should be positioned properly under and around all suspended activity.

### Hanging and adjusting height

- The Suspension and Height Adjustment System comes out of the bag fully as-

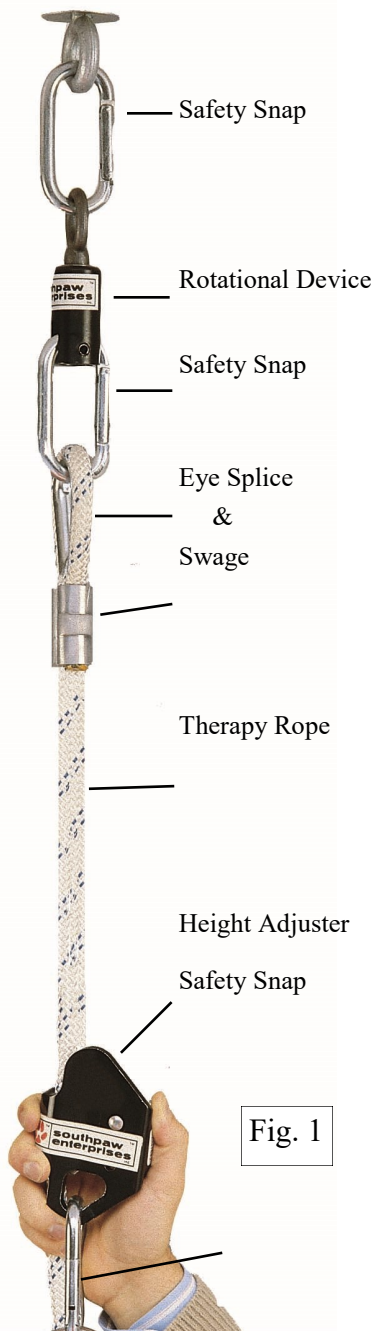

sembled and ready to hang. There is one safety snap which is attached to the Safety Trigger eye-splice of the rope. Attach this snap to your ceiling eyebolt. You are now ready to use your system.

- The following instructions explain how to adjust the height of the system, as well as how to re-attach the Height Adjuster if it is removed from the rope.
  1. Push the safety trigger upward to open the cam gate to attach to the rope (See figure 2).
  2. Your rope slips in here (See figure 3).
  3. To move the Height Adjuster up, hold pressure on the rope below the body and push up on the Height Adjuster to the desired height (See figure 4).
  4. To move the Height Adjuster down, release the lock on the cam by holding the rope below the Height Adjuster, and pushing up on the safety trigger while putting upward pressure on the Height Adjuster. This will unlock the cam and allow you to move the Height Adjuster to the desired height (See figure 4).

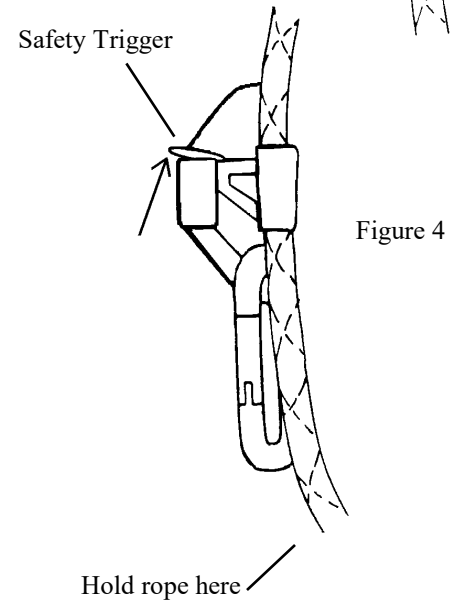
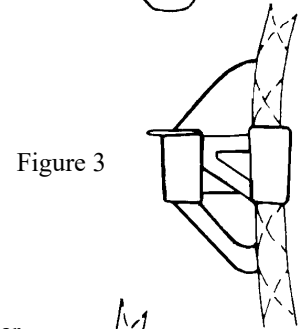
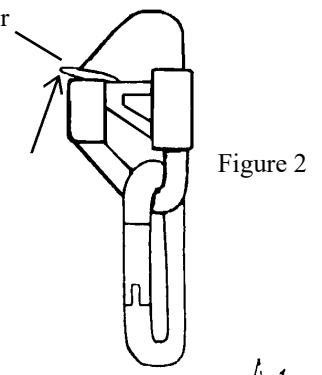

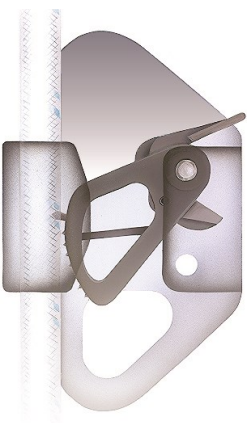

Height Adjuster Detail  
Working Load: 1000 lbs.

**To Shorten** Fig. 5 **Rope**

- Wrap cutting point with masking

tape. (Step A).

- Cut with a sharp knife in the middle of tape. (Step B). Take care not to pull rope sideways.
- Sear new exposed end using a lighter or stove. (Step C). (When using a stove make sure it is turned on high. Lower temperature will allow melted rope to stick to the stove.)

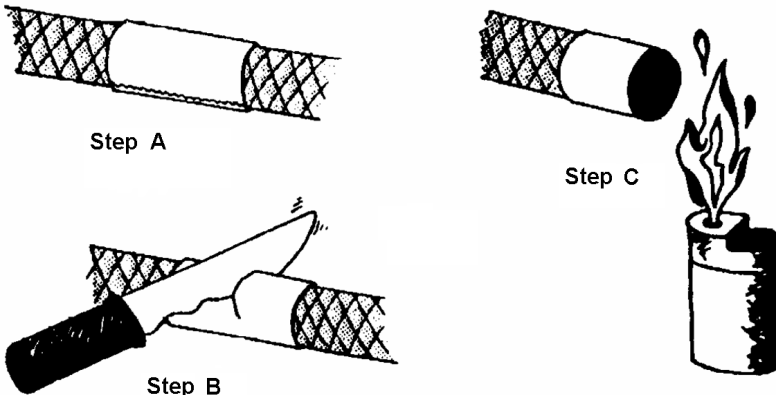

Fig. 6

### Rotational Device

Working Load 1000 lbs.

The Southpaw Safety Rotational Device comes pre-assembled to your system. In the event that it is removed for inspection, please keep the following in mind when you re-attach the rotational to the ceiling suspension point:

- Always attach the rotational device in the manner shown to the right. The label should be right-side up, and the eyebolt of the rotational on top. This helps prevent dust from entering the bearing.

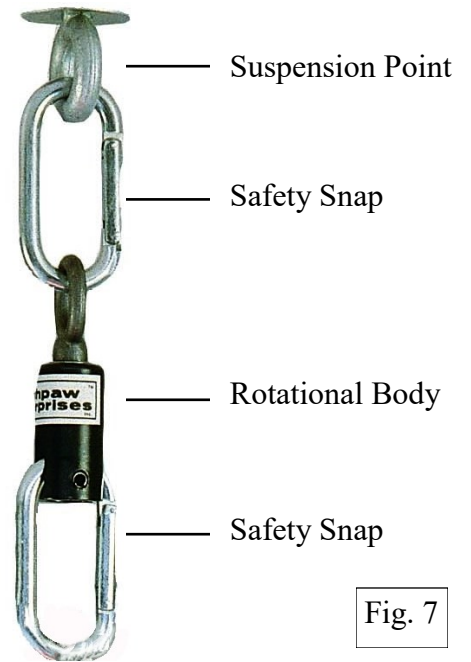
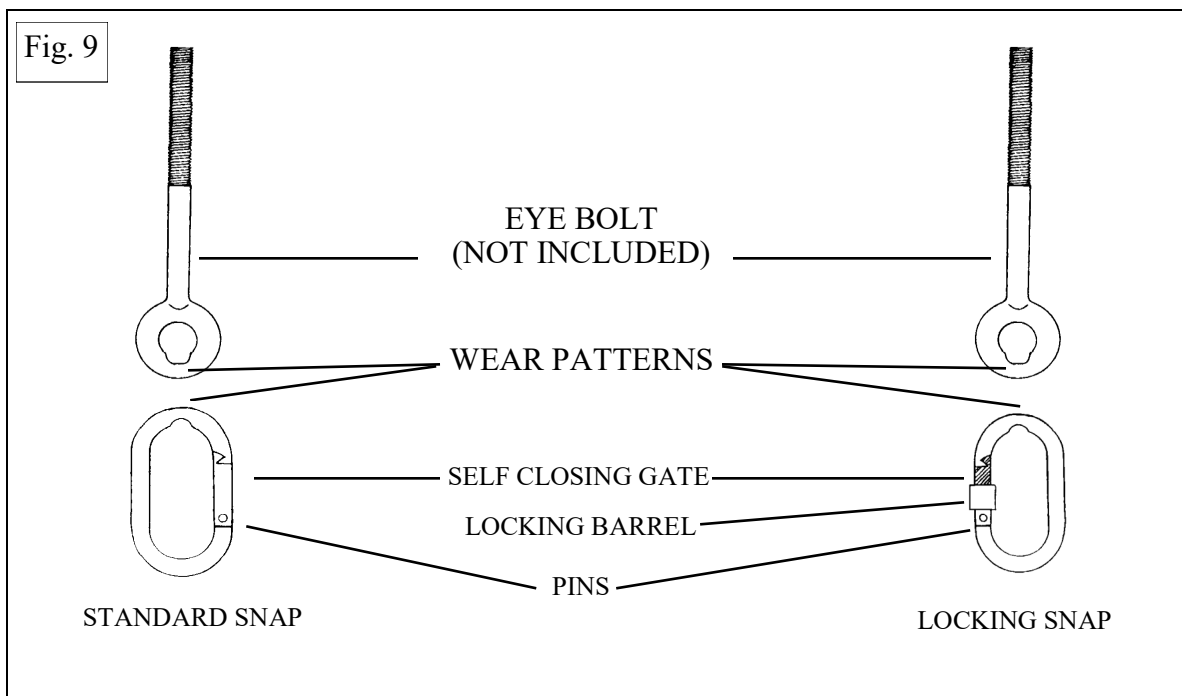
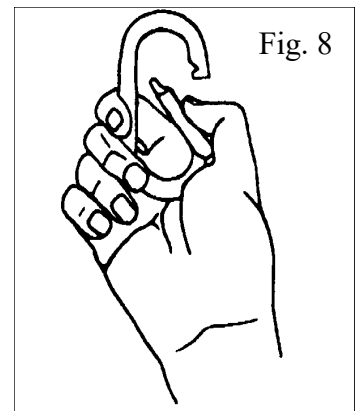

Fig. 7

### Safety Snap

Working Load 1000 lbs.

- Your Height Adjustment System comes with three safety snaps, as pictured in Fig. 1.
- To use your Southpaw Safety Snap simply open the gate by pushing on it with your thumb.
- Make sure the gate is fully closed before allowing a client to use the equipment
- **Important:** Take note of the wear pattern shown below. Read the maintenance checklist on page 4 for details.



### Maintenance and Cleaning Checklists

- All the following wear points should be checked monthly, and recorded on the enclosed maintenance checklist. Failure to do so could result in serious injury or death.

#### Height Adjuster

- Check the cam tips to be sure they are not bent or broken.
- Check to make sure that the spring in trigger fully closes the cam.
- Check for excessive wear (more than 50% of the thickness) at the contact point between the Safety Snap and Height Adjuster body.
- If problems are found with any of these inspection points, discontinue use immediately and contact Southpaw Enterprises for repair or replacement.

- √ Do not oil the Height Adjuster
- √ Do not immerse in water.
- √ Dust only, or blow with compressed air.

#### Safety Snap

- Check the top and bottom of the snap for wear against equipment and suspension eye bolt. (See fig. 9). If wear exists, it should not exceed 30% of the diameter of the safety Snap. If it does, discontinue use immediately, and replace.
- Check safety snap for sharp edges. It may be sanded smooth, unless sanding creates wear beyond the 30% limit.
- Check eye bolt for similar wear at the point where it rubs against the safety snap. If wear exists, it too should not exceed 30% of the diameter of the eye bolt. If it does, discontinue use immediately and replace. (See fig. 9).
- Make sure the self closing gate snaps closed properly and all pins are secure.
- √ Wipe with a dry cloth.

#### Rotational Device

- Grasp the "eye" of the Rotational Device in one hand, and the housing in the other. Pull them as if trying to separate them and, while pulling, twist them in opposite directions a few times. The sensation you feel should be one of smooth spinning. This indicates that the bearing is intact. If you feel any grittiness or grinding, then the bearing may be compromised and the Rotational Device should be replaced.
- Hold the Rotational Device by the "eye", or hang it from an eyebolt. Spin the rotational quickly. It should spin freely. If it spins, but then abruptly stops, then there is a contaminant in the bearing mechanism and the Rotational Device should be replaced.
- You may find that a dry bearing can squeak when turned in this fashion.. If that happens, spray a small amount of a very light lubricant (WD-40 or a silicone spray lubricant will work fine) into the housing . Try to spray as deep down as you can, so that the lubricant goes all the way to the bearing. Spin the Rotational Device a few time to work the lubricant in. Now try the "Twist" test again. If the bearing feels smooth when turning and pulling, the bearing is intact.
- A monthly application of a light lubricant as described above will help extend the useful life of the Rotational Device, but is not necessary for it to function properly.
- √ Do not wash or immerse in water.
- √ Can be cleaned with compressed air.

#### Therapy Rope

- Check to make sure short end of rope is sticking out of metal swage and loop has not enlarged. If loop has enlarged or short end of rope has slipped inside swage discontinue use.
- Check the metal lining in the loop at the top end of the rope, and the metal swage (Fig. 1), for sharp edges and wear. If sharp edges are present, they may be sanded smooth. If the loop is worn through completely discontinue use.
- Check rope for cuts or fraying. If rope appears to have broken fibers, discontinue use and replace at once.
- √ Do not try to clean rope
- √ Do not store in direct sunlight, or near chemicals.

### STORAGE PROCEDURES

- Store where not accessible by clients without proper supervision.
- Do not store in direct sunlight, or near household chemicals.

**Safety Precautions** - The safety of your clients is dependent on the appropriate choice of activity to match, yet challenge their physical abilities. Use appropriate spotting / safety techniques. In addition, the layout of your activity area, proper installation and maintenance of your equipment is critical. Southpaw equipment is not intended for recreational or outdoor use. Under no condition should this equipment be used without proper supervision.

**This sheet is for example only.** It is not meant to, in any way, replace local, county, state, or Federal standards. Be aware - it is your responsibility to find all pertinent safety information that pertains to your facility.

If you have any questions or comments, please call or write:

Southpaw Enterprises, Inc.

P.O. Box 1047, Dayton, Ohio 45401-1047

Toll Free - (800) 228-1698

Please visit us at [southpaw.com](http://southpaw.com)

© 2021 Southpaw Enterprises, Inc.